

## SPEAKER SC-N10

### Owner's Manual

### Manuel de l'Utilisateur

### Manuale delle istruzioni

### 取扱説明書

### Bedienungsanleitung

### Manual del usuario

### Gebruiksaanwijzing

### Bruksanvisning

### Руководство пользователя

### Instrukcja obsługi

### 操作说明书

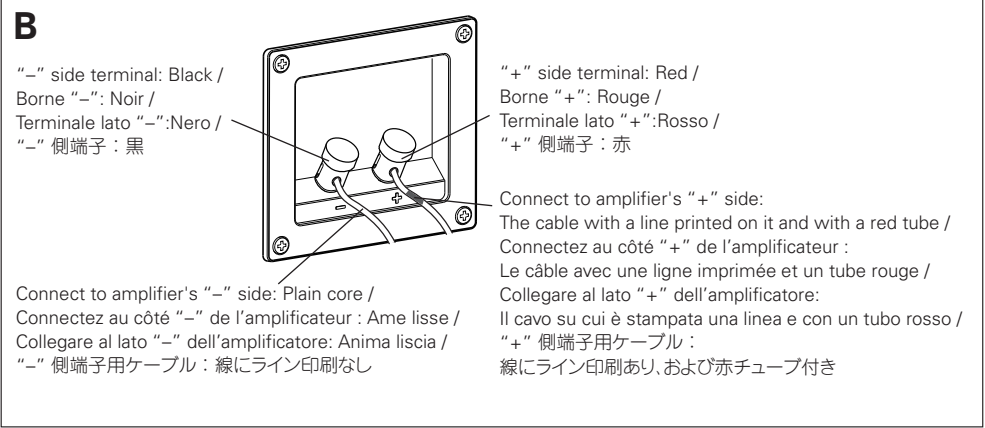
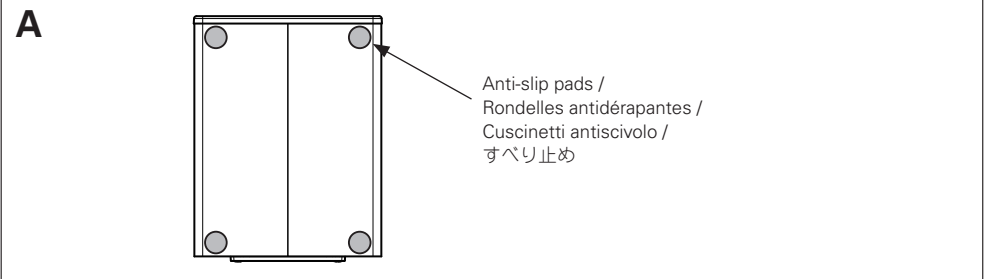
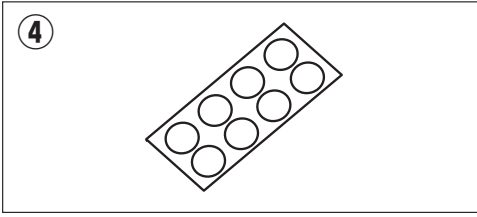
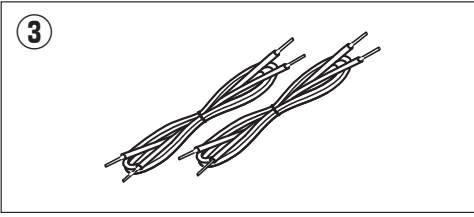
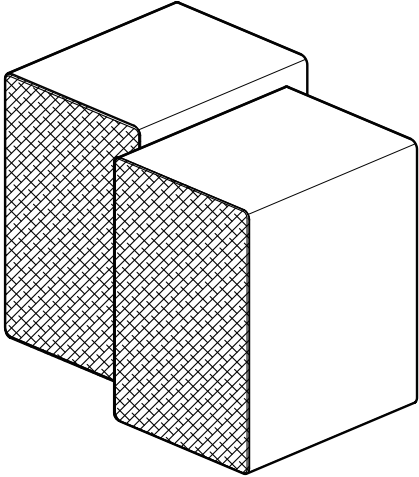

Thank you for purchasing this Denon product. To ensure proper operation, please read this owner's manual carefully before using the product.

After reading them, be sure to keep them for future reference.

#### Accessories

- ① Owner's Manual .....1
- ② Safety instructions .....1
- ③ Speaker cable .....2
- ④ Anti-slip pads (8 pcs. / 1sheet) .....1

#### Before using

#### Note on use

□ **Cautions on installation**  
The quality of the sound produced from the speaker is affected by the size and type of the room, as well as by the method of installation. Consider the points listed below before installing the speaker.

- If the bass sound is overemphasized when the speakers are installed directly on the floor, set them on concrete blocks or other hard stands.
- Note that placing the speaker on the same stand or shelf as a record player may result in howling.
- Also note that if there is a magnet or any device generating magnetic force nearby, interaction between this device and the speakers can cause the colors on the TV to become biotchy.

#### WARNING

- Be sure to fasten the speaker cables to a wall, etc., to prevent people from tripping over them or otherwise pulling on them accidentally, causing the speakers to fall.
- Be sure to check for safety after installing the speakers. Afterwards, perform safety inspections at regular intervals to be sure there is no danger that the speakers will fall. Denon will not be liable for damages or accidents caused by inappropriate choice of the place of installation or improper installation procedures.

- **Cleaning**
- Use a dry wiping cloth and wipe lightly to remove dirt from the cabinet and operation panel.
- When using chemically treated cloths, follow the precautions provided for them.
- Do not use benzene, thinners, or other organic solvents or insecticides on the speakers since they may cause a change in quality or color.

- **Other cautions**
- Raising the amplifier's volume excessively and playing with distorted sound could damage the amplifier and speakers. Enjoy the sound at a reasonable volume level.
- When moving the unit, note that applying strong force to the surface of the speaker through the saran net could damage the speaker.
- The Saran net on the front of the speakers cannot be removed.

#### How to Install

Attach four of the included anti-slip pads to the bottom of the unit. (☞**A**)

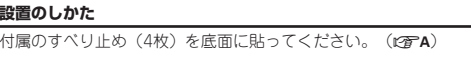
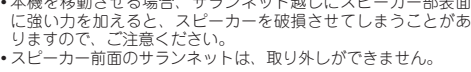
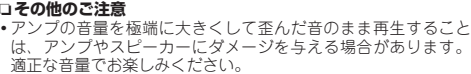
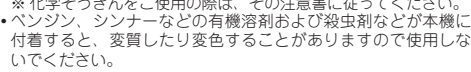
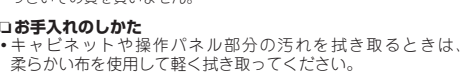
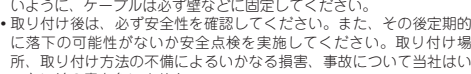
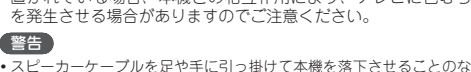
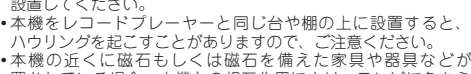
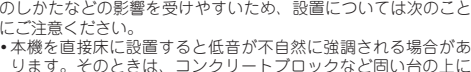
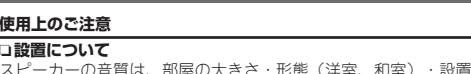
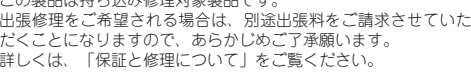
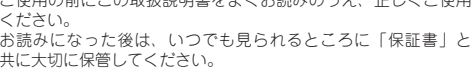
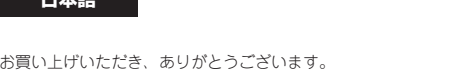

#### Connections

When connecting the speakers to an amplifier, be sure to read the amplifier's owner's manual carefully and connect properly.

- Connect the input terminals on the rear panel of the speaker with the speaker output terminals on the amplifier, using the included speaker cables.

- Connect the speaker for the left channel to the "L" terminal on the amplifier, the speaker for the right channel to the "R" terminal on the amplifier, making sure to check the polarities ("+" and "-"). (☞**B**)

• Amplifiers have various speaker output terminals. Check the owner's manual of the amplifier you are using for details.

#### NOTE

- Be sure to turn the amplifier's power off before connecting the speakers to the amplifier.
- If the polarities are inverted, the phase may be off and the sound may have no bass component, making it seem unnatural. Be sure to connect the polarities properly.

## 1 Push the speaker terminal and insert the speaker cable into the cable insertion slot.

## 2 Release your finger from the speaker terminal to fix the speaker cable.

Once connections are completed, pull gently on the speaker cables to check that they are securely connected.

#### NOTE

- Do not let the core wires of two speaker cables touch each other. Doing so will short-circuit the amplifier circuitry and damage the amplifier.

Specifications	
Type:	2-way · 2speakers Reflex box
Frequency range:	50 Hz ~ 20 kHz
Input impedance:	6 Ω/ohms
Max. input:	60 W (IEC), 120 W (PEAK)
Sensitivity:	85 dB (1 W · 1 m)
Crossover frequency:	3.5 kHz
Speakers:	12 cm (4-23/32") cone bass-mid x 1 3 cm (1-3/16") balance dome high-range x 1
Maximum external dimensions:	153 (W) x 233 (H) x 200 (D) mm (6-1/32" x 9-11/64" x 7-7/8") 2.4 kg (5 lbs 5 oz)
Weight:	
	For improvement purposes, specifications and design are subject to change without notice.

Nous vous remercions d'avoir acquis cet appareil Denon. Afin d'assurer son bon fonctionnement, veuillez lire attentivement ce manuel de l'utilisateur avant d'utiliser l'appareil.
Après l'avoir lu, conservez-le afin de pouvoir vous y reporter ultérieurement.

#### Accessoires

- ① Manuel de l'Utilisateur .....1
- ② Instructions de sécurité .....1
- ③ Câble d'enceinte avant d'utiliser l'appareil .....2
- ④ Rondelles antidérapantes (8 pavés / 1feuille) .....1

#### Avant l'utilisation

#### Observations relatives à l'utilisation

#### Précautions d'installation

La qualité du son produit par le enceintes est affectée par la taille et la forme de la pièce, ainsi que par la méthode d'installation. Soyez attentifs aux remarques inscrites ci-dessous avant l'installation des enceintes.

- Si le son des basses est excessif lorsque les enceintes sont installées directement sur le sol, placez-les sur des blocs de béton ou sur un autre support dur.

- Veuillez noter que quand le enceintes est disposé sur le même support ou la même étagère qu'une platine disque, un bruit gênant peut se produire.

- Notez également que si un aimant ou un autre appareil générant une force magnétique se trouve à proximité, une interaction entre cet appareil et les enceintes peut brouiller les couleurs de la télévision.

#### AVERTISSEMENTS

- Fixez les câbles d'enceinte au mur, etc., afin d'éviter de vous y prendre les mains ou les pieds et de faire tomber les enceintes.
- Veillez à effectuer un contrôle de sécurité après l'installation des enceintes. Par la suite, effectuez des contrôles de sécurité régulièrement pour vous assurer que les enceintes ne risquent pas de tomber. Denon n'acceptera aucune responsabilité pour des dégâts ou accidents causés par un choix inapproprié du lieu d'installation ou par des procédures d'installation incorrectes.

- **Nettoyage**
- Utilisez un chiffon et essuyez légèrement afin d'ôter la poussière desobstriers et du panneau de commande.
- Lorsque vous utilisez des chiffons traités chimiquement, respectez les mesures de précaution jointes à ces produits.
- Ne pas utiliser de benzène, de dissolvant ou d'autres solvants organiques, ou d'insecticides pour nettoyer l'unité principale, car ils risquent d'en altérer la qualité ou la couleur.

#### Autres Précautions

- Vous risquez d'endommager l'amplificateur et les enceintes si vous augmentez trop le volume de l'amplificateur et produisez un son distordu. Appréciez le son à un niveau de volume raisonnable.
- Lorsque vous déplacez les enceintes, veuillez remarquer que vous risquez de les endommager si vous exercez une forte pression au niveau du filet de protection.
- Le filet de protection qui se trouve sur l'avant des enceintes n'est pas amovible.

#### Installation

Fixez quatre des patins antidérapants en dessous de l'unité. (☞**A**)

#### Connexions

Afin d'effectuer les connexions correctement, lisez attentivement le mode d'emploi de l'amplificateur.

- Connectez les bornes d'entrée situées sur le panneau arrière des enceintes aux bornes de l'amplificateur, à l'aide des câbles d'enceinte (Fourm).
- Connectez l'enceinte de la voie gauche à la borne "L" de l'amplificateur, l'enceinte de la voie droite à la borne "R" de l'amplificateur, en vérifiant les polarités ("+" et "-"). (☞**B**)
- Les amplificateurs sont dotés de différents types de bornes de sortie d'enceintes.

Vérifiez le mode d'emploi de votre amplificateur.

#### REMARQUE

- L'amplificateur doit être mis hors tension avant d'y connecter les enceintes.
- Si les polarités sont inversées, les enceintes risquent d'être horsphase et les basses ne seront alors pas reproduites correctement. Assurez-vous de connecter les polarités correctement.

## 1 Enfoncez la borne d'enceintes et insérez le câble d'enceinte dans la fente d'insertion du câble.

## 2 Retirez votre doigt de la borne d'enceintes pour fixer le câble d'enceinte.

Lorsque les connexions sont terminées, tirez doucement sur les câbles d'enceinte pour vous assurer qu'ils sont fermement connectés.

#### REMARQUE

- Ne pas laisser les fils de deux câbles d'enceinte entrer en contact. Ceci causerait un court-circuit et endommagerait l'amplificateur.

Spécifications	
Type:	2-enceintes à 2-voies Caisson de résonance
Gamme de fréquence:	50 Hz ~ 20 kHz
Impédance d'entrée:	6 Ω/ohms
Puissance max:	60 W (IEC), 120 W (PEAK)
Sensibilité:	85 dB (1 W · 1 m)
Fréquence de croisement:	3,5 kHz
Enceintes:	1 x cônes bass-mid de 12 cm (4-23/32") 1 x dôme balance haut de gamme 3 cm (1-3/16")
Dimensions externes maximales:	153 (L) x 233 (H) x 200 (P) mm (6-1/32" x 9-11/64" x 7-7/8") 2,4 kg (5 lbs 5 oz)
Poids:	
	Par souci d'amélioration, les caractéristiques et le design sont susceptibles de modifications sans préavis.

### ITALIANO

Grazie per avere acquistato questo prodotto Denon. Per un funzionamento corretto, assicurarsi di leggere attentamente il presente manuale delle istruzioni prima di utilizzare il prodotto. Una volta letto, custodirlo per consultazioni future.

Accessori	
① Manuale delle istruzioni .....1	
② Istruzioni per la sicurezza .....1	
③ Cavo dell'altoparlante .....2	
④ Cuscinetti antiscivolo (8 pezzi / 1 foglio) .....1	

#### Prima dell'uso

#### Note sull'uso

#### Precauzioni sull'installazione

La qualità del suono emesso dai altoparlanti dipende dalla grandezza e dal tipo dell'ambiente nonché dal metodo di installazione. Prima di installare il altoparlanti, osservate i seguenti punti.

- Se il suono dei bassi è troppo enfatizzato quando gli impianti di altoparlanti sono collocati direttamente a contatto con il pavimento, posizionarli su blocchi di cemento o altri supporti rigidi.
- Il posizionamento dei altoparlanti sullo stesso supporto o sulla stessa mensola di un videoregistratore può provocare interferenze.

- Notare inoltre che se vicino all'unità è presente un magnete o un dispositivo che genera forza magnetica, l'interazione tra tale dispositivo e gli impianti di altoparlanti può comportare una visualizzazione a macchie dei colori sul televisore.

#### AVVERTENZA

- Fissare i cavi dell'altoparlante alla parete ecc., in modo da non rimanere impigliati e far cadere l'unità.
- Dopo l'installazione dei altoparlanti, verificate che siano sicuri. Dopodiché, eseguire il controllo di sicurezza a intervalli regolari per assicurarsi che non vi sia pericolo che gli impianti di altoparlanti cadano. Denon declina ogni responsabilità per danni o incidenti dovuti alla scelta di un luogo di installazione inappropriato oppure a procedure di installazione errate.

#### Pulizia

- Utilizzare un panno per pulire delicatamente l'unità e rimuovere la sporcizia dall'involucro e dal pannello di controllo.
- Quando si utilizzano panni trattati chimicamente, adottare tutte le precauzioni necessarie.
- Non utilizzare benzene, diluenti, altri solventi chimici o insetticidi sull'unità principale, poiché possono deteriorarne la qualità o modificare il colore.

#### Altre precauzioni

- Un volume eccessivo dell'amplificatore e la riproduzione di suoni distorti possono arrecare danni agli altoparlanti e all'amplificatore. Ascoltare la musica mantenendo il volume a livelli non eccessivi.
- Nello spostare l'unità fare attenzione a non applicare un'eccessiva pressione sulla superficie dell'altoparlante attraverso la rete saran, poiché ciò potrebbe arrecare danni all'altoparlante.
- La rete Saran sulla parte anteriore degli altoparlanti non può essere rimossa.

#### Modalità di installazione

Fissare quattro dei piedini antiscivolo in dotazione sul fondo dell'unità. (☞**A**)

#### Collegamenti

Prima di effettuare i collegamenti, leggere attentamente il manuale delle istruzioni dell'amplificatore in modo da collegarlo in maniera adeguata.

- Collegare i terminali di ingresso collocati nel pannello posteriore dei altoparlanti con i terminali d'uscita dell'altoparlante sull'amplificatore utilizzando i cavi dell'altoparlante (in dotazione).
- Collegare il altoparlanti per il canale sinistro al terminale "L" dell'amplificatore e il altoparlanti per il canale destro al terminale "R" dell'amplificatore, controllando inoltre le polarità ("+" e "-"). (☞**B**)

- Ci sono diversi tipi di terminali d'uscita dell'altoparlante sugli amplificatori. Controllare il manuale delle istruzioni dell'amplificatore.

#### NOTA

- Se le polarità sono invertite, la fase potrebbe essere spenta e l'audio potrebbe non avere i toni bassi, risultando quindi innaturale. Collegare le polarità in maniera corretta.

## 1 Spingere il terminale del cavo e inserire il cavo dell'altoparlante nella fessura di inserimento del cavo.

## 2 Levare il dito dal terminale dell'altoparlante per fissare il cavo dell'altoparlante.

Dopo aver completato i collegamenti, tirare leggermente i cavi dell'altoparlante per assicurarsi che siano collegati saldamente.

#### NOTA

- Evitare che le anime dei due cavi di collegamento entrino in contatto. In caso contrario, la crituriera dell'amplificatore andrà in corto circuito, arrecando danni all'amplificatore.

Specifiche	
Tipo:	2-vie · 2altoparlanti Involucro Reflex
Gamma di frequenza:	50 Hz ~ 20 kHz
Impedenza di ingresso:	6 Ω/ohm
Impedenz max:	60 W (IEC), 120 W (PEAK)
Sensibilità:	85 dB (1 W · 1 m)
Frequenza di crossover:	3,5 kHz
Altoparlanti:	12 cm cono bass-midi x 1 3 cm high range a cupola bilanciato x 1
Dimensioni esterne massime:	153 (L) x 233 (A) x 200 (P) mm
Massa:	2,4 kg

Per motivi di miglioramento, dati tecnici e design sono soggetti a modifiche senza preavviso.

### 日本語

お買い上げいただき、ありがとうございます。
ご使用の前にこの取扱説明書をよくお読みのうえ、正しくご使用ください。

お読みになった後は、いつでも見られるところに「保証書」と共に大切に保管してください。
この製品は持ち込み修理対象製品です。
出張修理をご希望される場合は、別途出張料をご請求させていただきますこととなりますので、あらかじめご了承ください。
詳しくは、「保証と修理について」をご覧ください。

付属品について	
①取扱説明書（保証書を含む） .....1	
②安全にお使いいただくために .....1	
③スピーカーケーブル .....2	
④すべり止め（1シート8枚） .....1	

#### ご使用になる前

#### 使用上のご注意

□ **設置について**  
スピーカーの音質は、部屋の大きさ・形態（洋室、和室）・設置のしかたなどの影響を受けやすいため、設置においては次のことにご注意ください。

- 本機を直接床に設置すると低音が不自然に強調される場合があります。そのときは、コンクリートブロックなど固い台の上に設置してください。
- 本機をレコードプレーヤーと同じ台や棚の上を設置すると、ハウリングを起すことがありますので、ご注意ください。
- 本機の近くに磁石もしくは磁石を備えた家具や器具などが置かれている場合、本機との相互作用により、テレビに色むらを生じさせる場合がありますのでご注意ください。

#### 警告

- スピーカーケーブルを足や手に引っ掛けて本機を落下させることのないように、ケーブルは必ず壁などに固定してください。
- 取り付け時は、必ず安全性を確認してください。また、その後定期的に落下の可能性がないか安全点検を実施してください。取り付け場所、取り付け方法の不備によるいかなる損害、事故について当社はいっさいその責を負いません。

#### □お手入れのしかた

- キャビネットや操作パネル部分の汚れを拭き取るときは、柔らかい布を使用して軽く拭き取ってください。
- 洗浄剤などをご使用の際は、その注意書に従ってください。
- ペンシラン、シンナーなどの有機溶剤および殺虫剤などが本機に付着すると、変質したり変色することがありますので使用しないでください。



